

Eleiko IWF Weightlifting Competition Podium

Art.no. 3085268

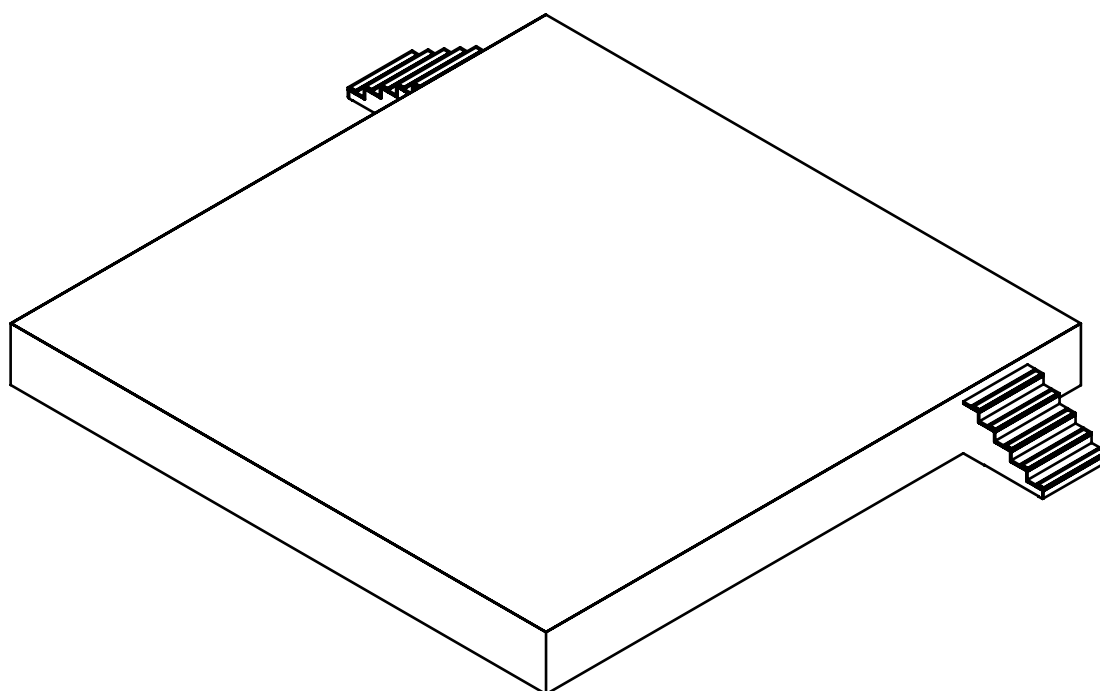

ELEIKO

READ BEFORE INSTALLATION AND USE

CAUTION

The equipment must be installed and used in a place whose access and supervision are specifically controlled by the owner.

Be sure to install the equipment on a stable base and properly level the equipment. ELEIKO recommends that all equipment installed by a professional and licensed contractor or an ELEIKO-installer.

SAFETY INSTRUCTIONS

It is the responsibility of the purchaser of ELEIKO products to instruct all users and supervising personnel on proper usage of the equipment.

1. All included warnings (labels) and instructions **MUST** be read before the use of any ELEIKO-equipment. Use each equipment as it is intended for.
2. A user **MUST** get a medical examination and proper instructions before the use of any ELEIKO-equipment.
3. **DO NOT** let anyone, under any circumstances, use equipment that appears to be damaged. Do not try to repair any equipment before consulting an ELEIKO technician.
4. **DO NOT** replace the components of ELEIKO-equipment with other none ELEIKO-equipment (magnetic safety pin, frames, bars), do not improvise. If there are any doubts consult an ELEIKO representative prior to any intervention.
5. **DO NOT** overload the equipment and **DO NOT** try to exceed personal strength levels.
6. Children under the age of 14 must be supervised by an adult.
7. **DO NOT** remove any safety labels from the ELEIKO-equipment. ELEIKO is not responsible if a label is removed. Replace damaged labels immediately.

PREVENTITIVE MAINTENANCE & INSPECTIONS

DAILY:

Cleaning of Carpet with a proper vacuum cleaner.

REGULARLY:

Clean the banners and stairs from dust and dirt.

Check that all bolts between parts, walls, floors are properly tightened, according to recommendations.

Check equipment for sharp edges and replace if necessary.

Check tubes and welds for cracks or other defects, replace if necessary.

WARRANTY

All products manufactured by ELEIKO are warranted to the original purchaser to be free from defects in workmanship and / or materials under normal use or service as follows: 2 years

10 years on welds on structural frame (NOT on moving parts)

Normal wear and tear does not fall under the warranty. Carpet and banners no warranty.

ADDITIONAL INFORMATION

This equipment is for indoor use only.

ELEIKO

PRODUCT SPECIFICATIONS

Eleiko IWF weightlifting podium is used for weightlifting competitions. The product is designed to work with Eleiko weightlifting competitions platforms. All measures are in compliance with IWF rules and regulations for podium. Also make sure you place the platform according to IWF rules and regulations. Pay a lot of attention to level the construction before you place the plywood layer. Important for safety, performance and lifetime of product to have a flat and levelled podium.

Product weight	6761 kg	14905 LBS
Max user body weight	200 kg	441 LBS
Max weight on bar	300 kg	661 LBS
Dimensions (L x W x H)	10x10x1 (m)	32,8 x32,8x3,3 (ft)

FOOTPRINT AREA

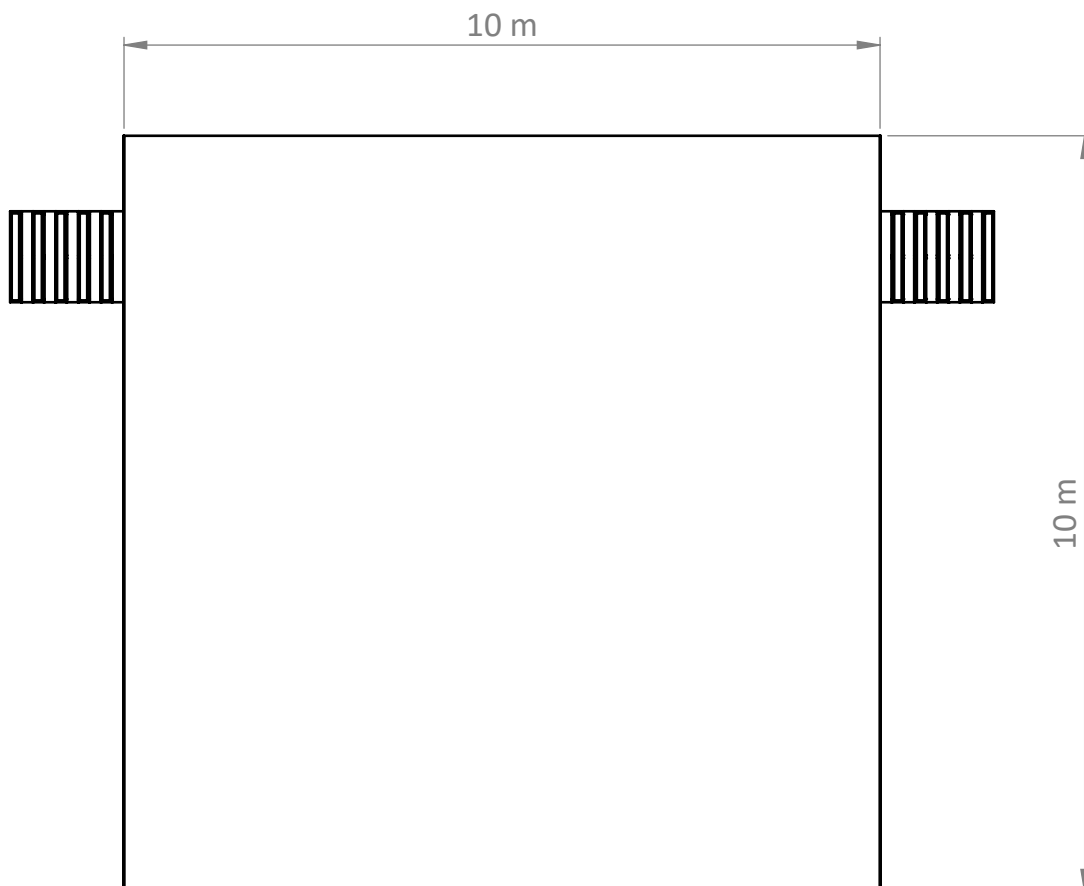

ELEIKO

CONTENTS

X80

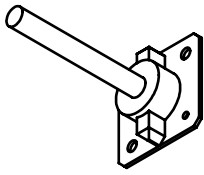

Foot, UJB 38-36/17, 116762 , Peri 2001029

X80



Spindel Locking UJS, 100863, Peri 2001053

X80

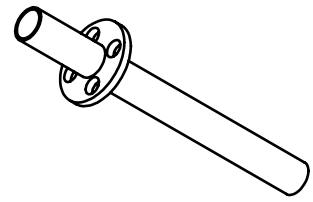

Spira Top, UVH 50, 101309, Peri 2001030

X40

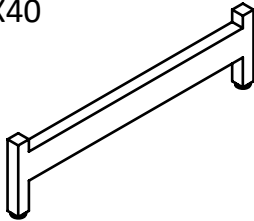

Support Beam short L=500 plus, 114595, Peri 2001031

X8

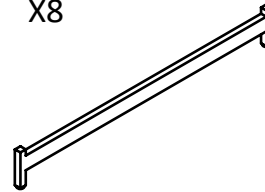

Support Beam long L=1000 plus, 114632, Peri 2001035

X88

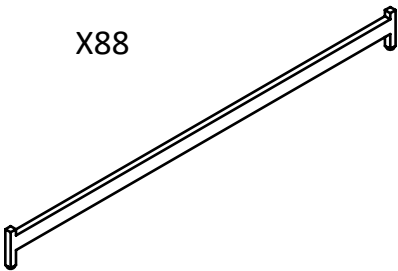

Support Beam UH L=1500 plus, 114641, Peri 2001059

X80

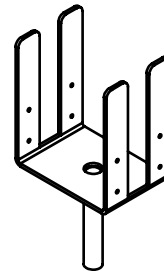

Holder Top, 028680, 20/24 S, Galv, Peri 2001036

X4

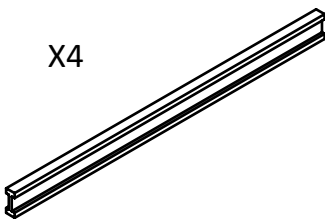

Beam, 074920, VT20K, L=2900, Peri 2001038

X78

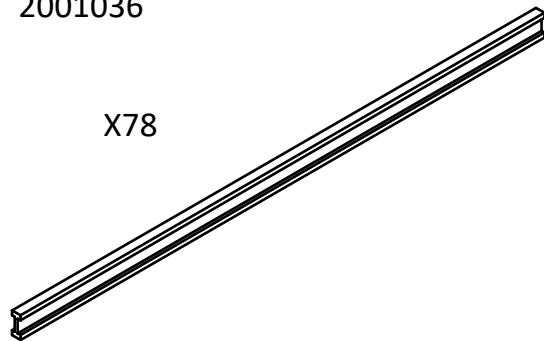

Beam, 074970, VT20K, L=4900, Peri 2001058

X286

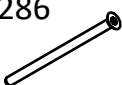

Screw, Spax6x100 SK-TX 30, Gul galv, 024950, Peri 2001039

X400

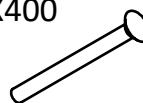

Wood Screw 4,5x45
2000443

CONTENTS

X64

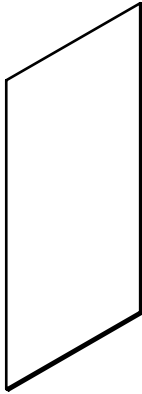

Plywood for Podium FFBjörk1250x2500x21 BB/WG Ext
2000437

X2

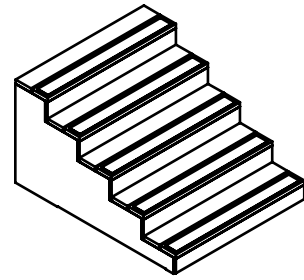

Staircase for Podium IWF
2001052

X1

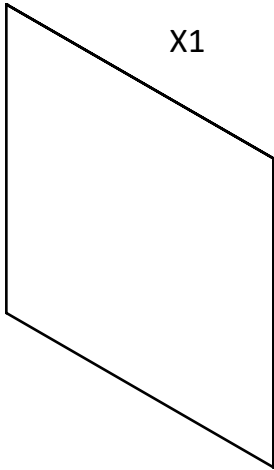

Carpet for podium, Grey 10x10 m
2001048

X1

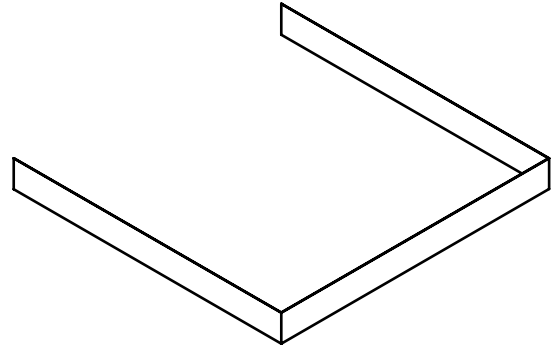

Banner L=30 m h= 1 m, Grey
2001049

X5

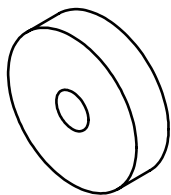

double-sided tape
3062723

REQUIRED TOOLS



Bits TX 30
2001079



Bits TX 25
2001123

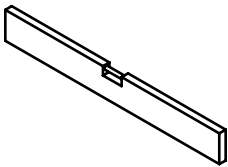

Spirit level
3061108
Not included

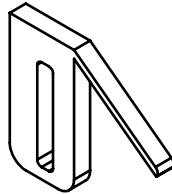

staple gun
Not included



rotating laser
Professional
Not included

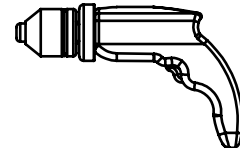

Screwdriver for bits, battery
Not included

ASSEMBLY INSTRUCTIONS

1.

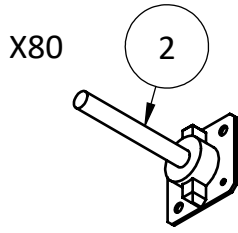

X80
Foot
2001029

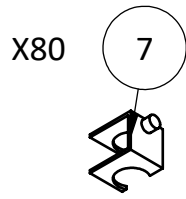

X80
Spindel locking
2001053

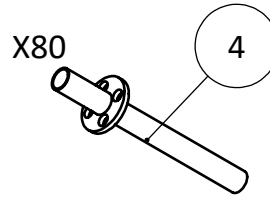

X80
Spira
2001030

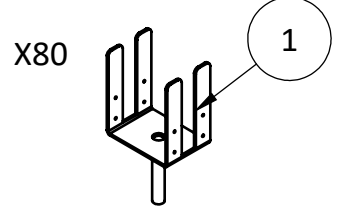

X80
Holder top
2001036

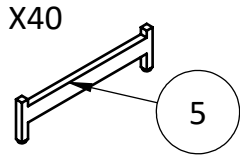

X40
Support beam L=500
2001031

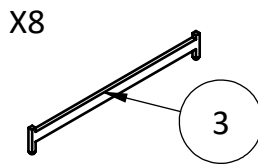

X8
Support beam L=1000
2001035

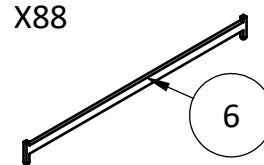

X88
Support beam L=1500
2001059

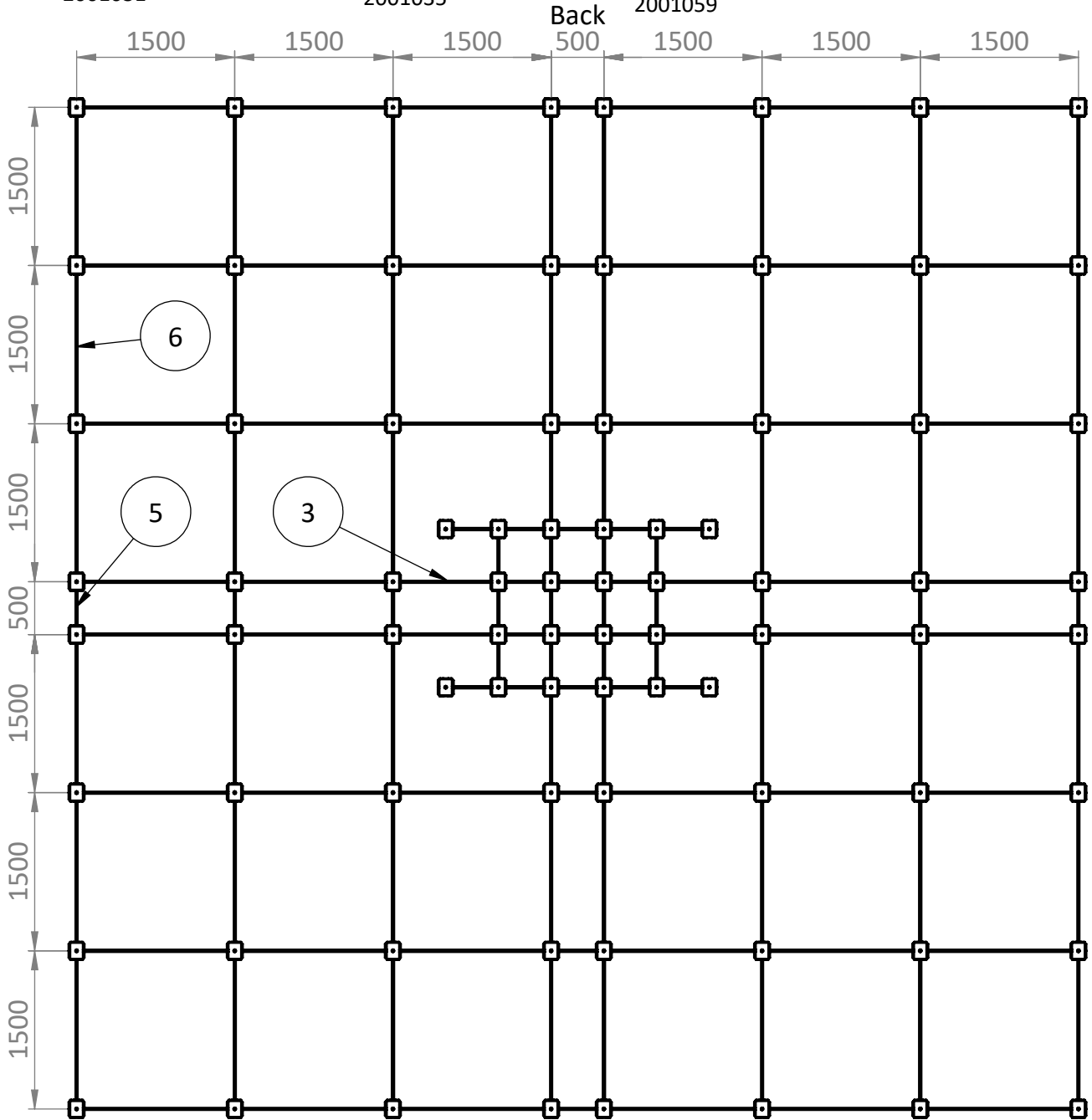
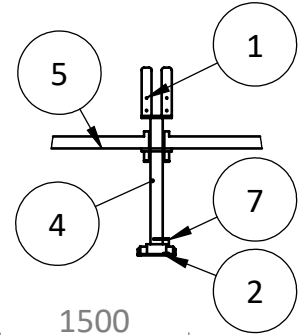

Front

ELEIKO

ASSEMBLY INSTRUCTIONS

1.

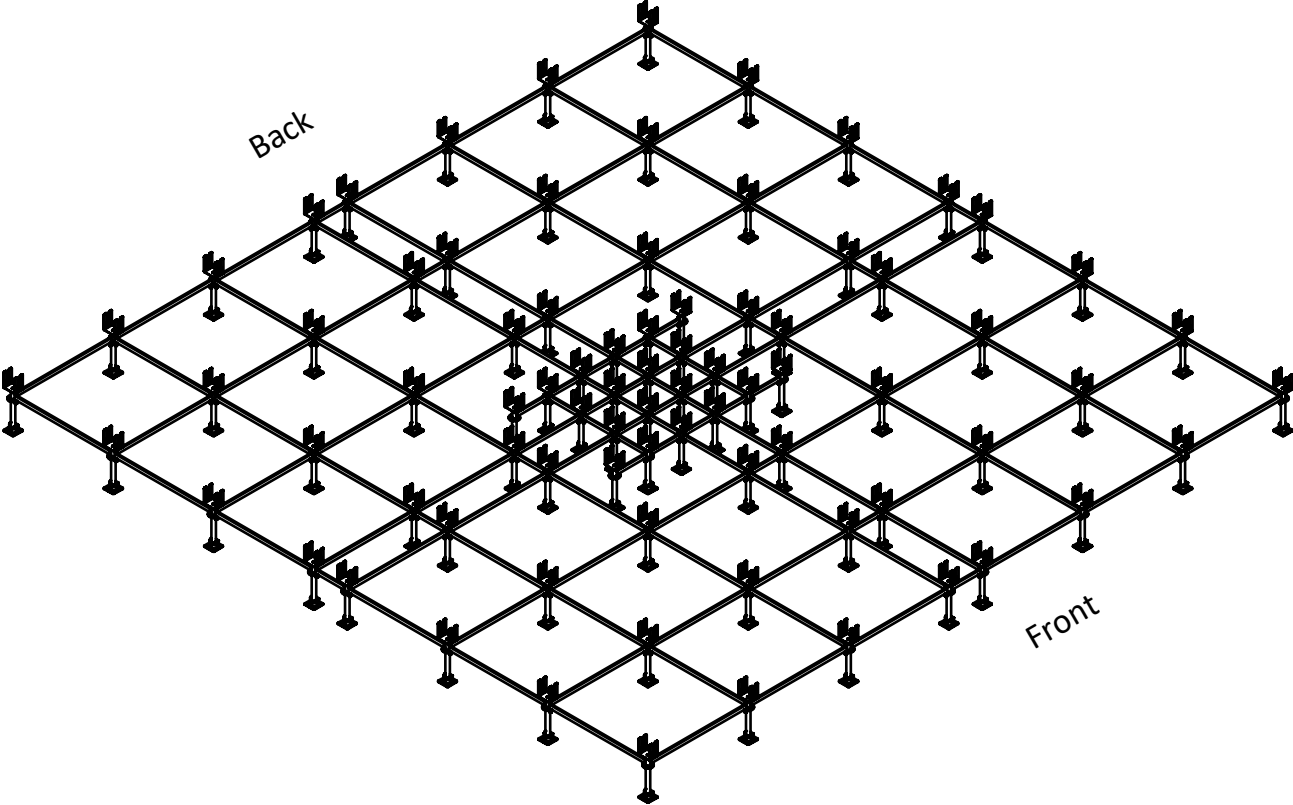

2.



rotating laser
Not included

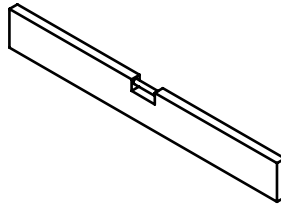

Spirit level
3061108
Not included

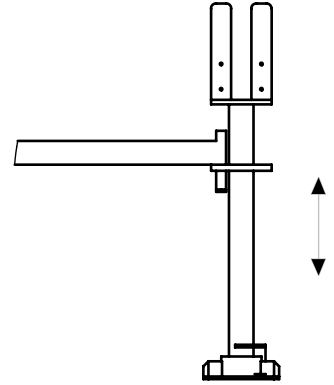

For best result use a rotation laser to align the height of **all** holder. Second best is a spirit level.
Use the screw on the foot to adjust height.
Keep the height as low as possible.
Lock the screw with spindel locking.
Be extra precisely in center of podium 5x5 m.
Max deviation 2 mm/ 1000 mm.

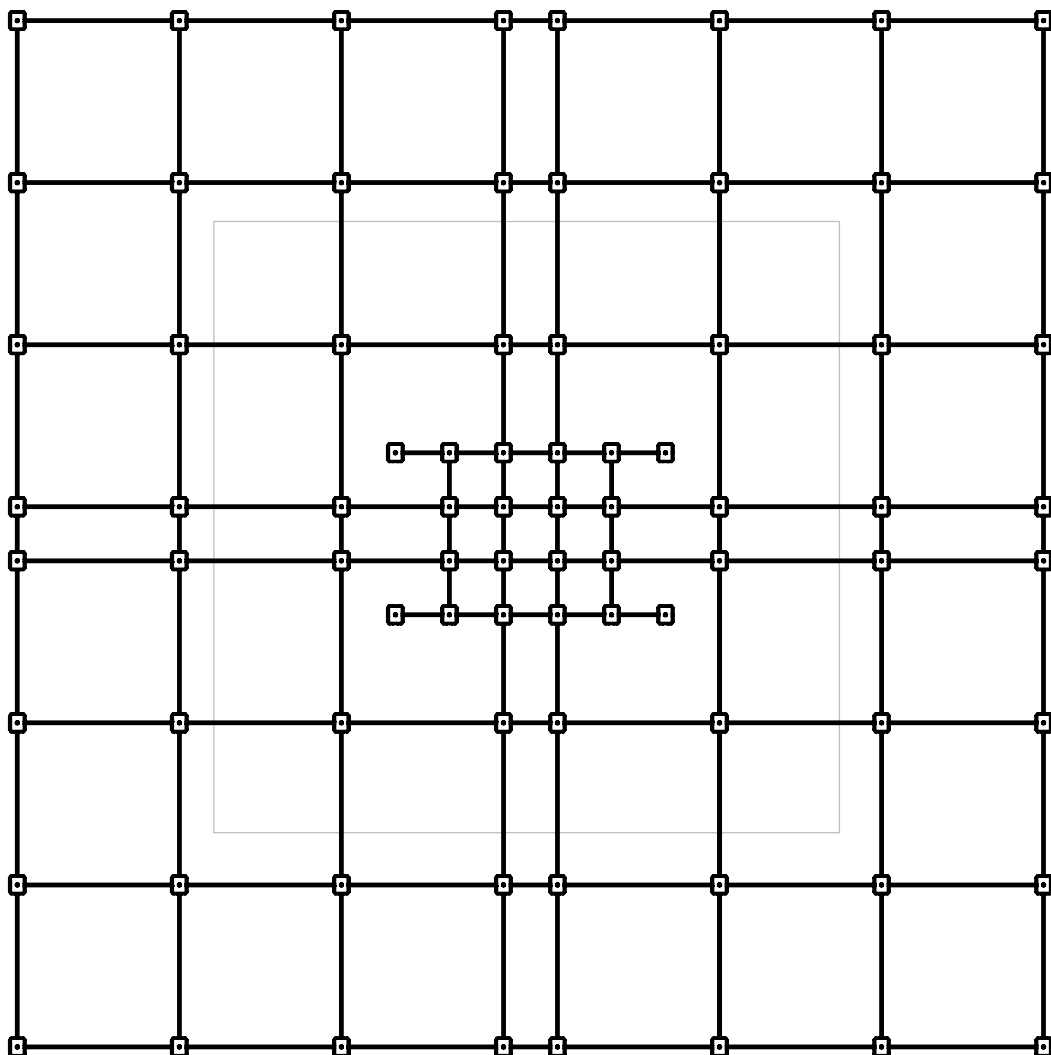
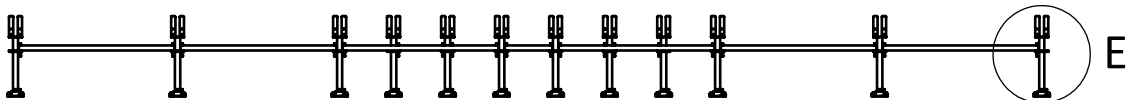

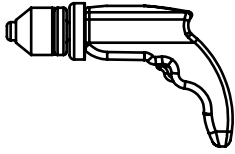

Bits TX 25
2001123

3. Screwdriver for bits, battery
Not included

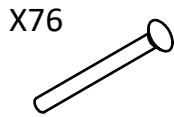

X76
Wood Screw 4,5x45
2000443

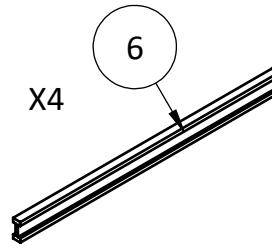

X4
Beam L=2900
2001038

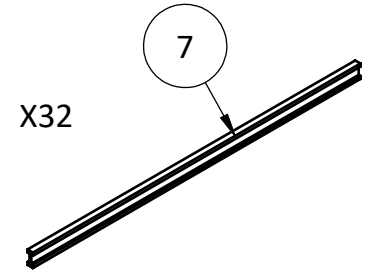

X32
Beam L=4900
2001058

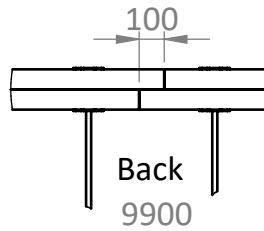

• Pattern for wood screws

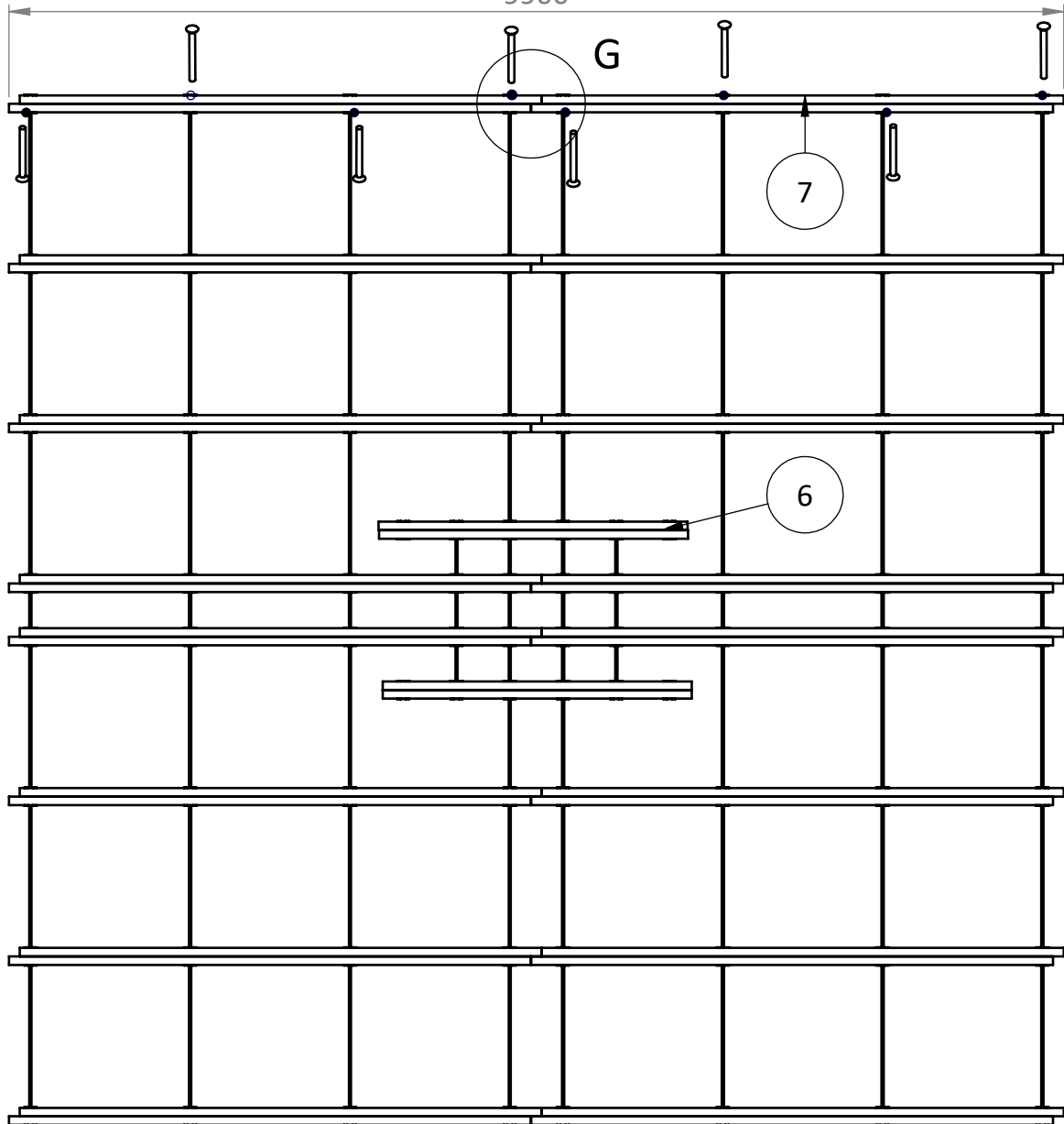

3.

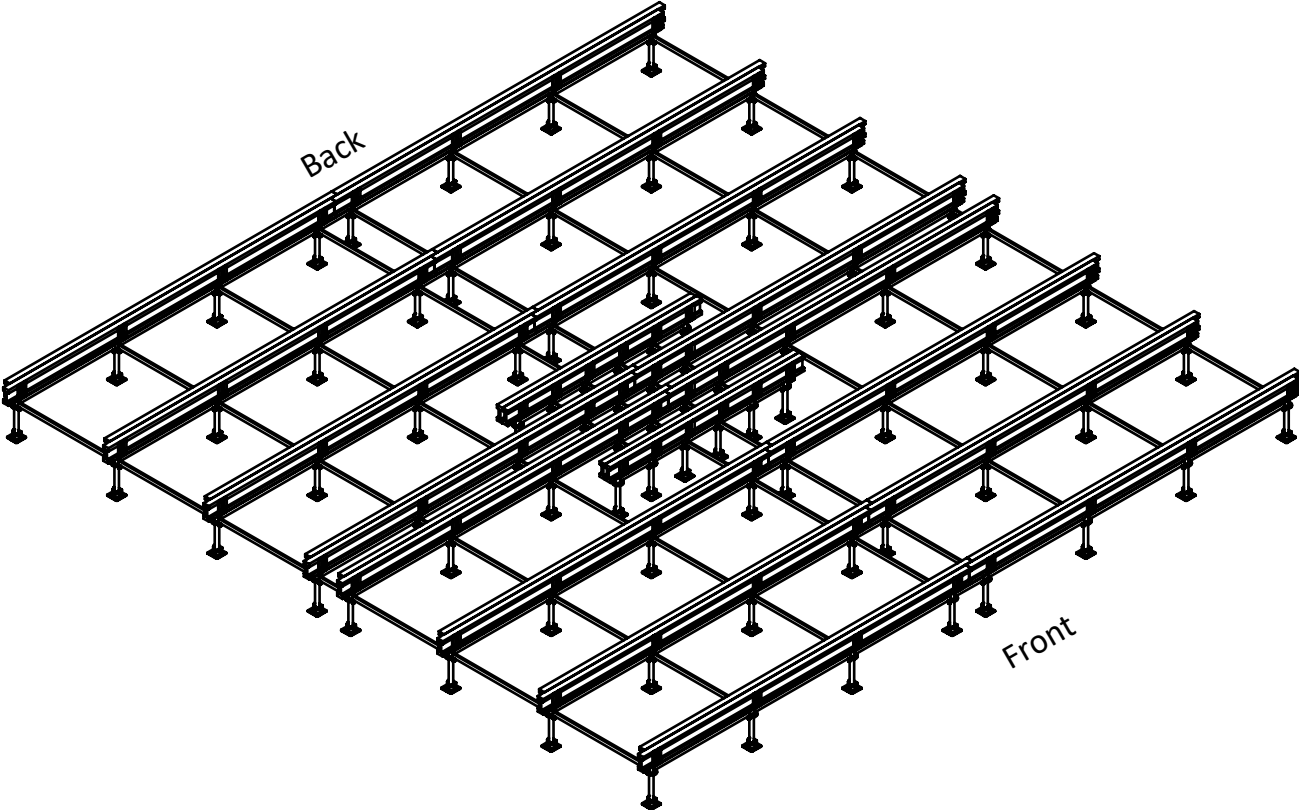

4.

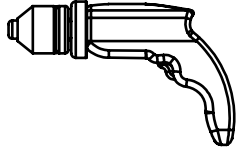

Screwdriver for bits, battery
Not included



Bits TX 30
2001079

X46

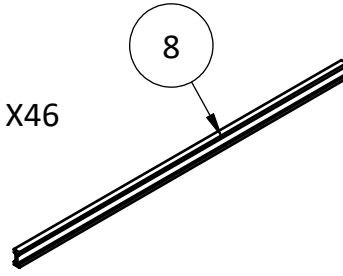

Beam L=4900
2001058

X286

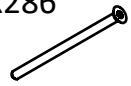

Screw, Spax 6x100
2001039

● Pattern for screws

Back

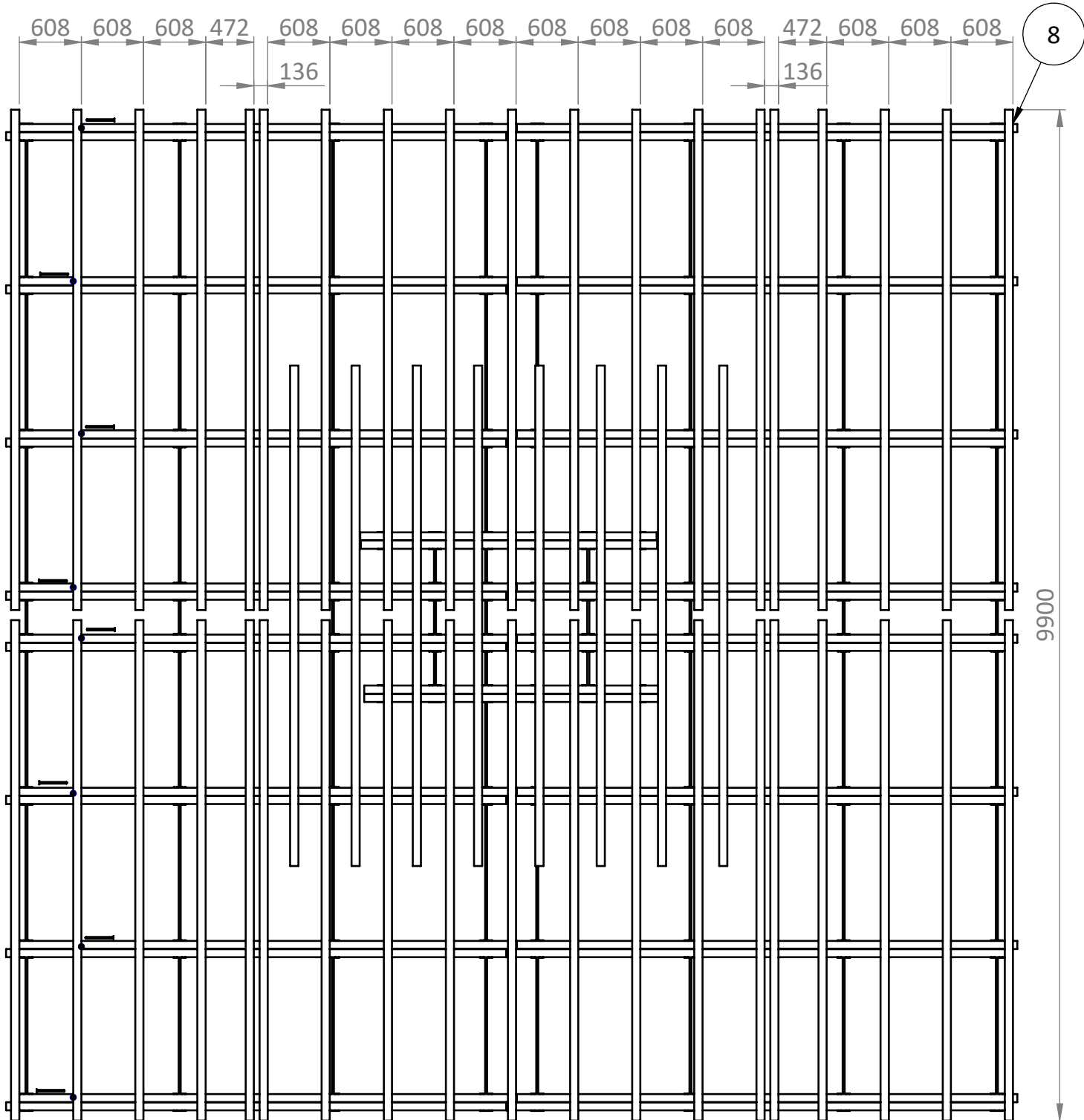

Front

ELEIKO

4.

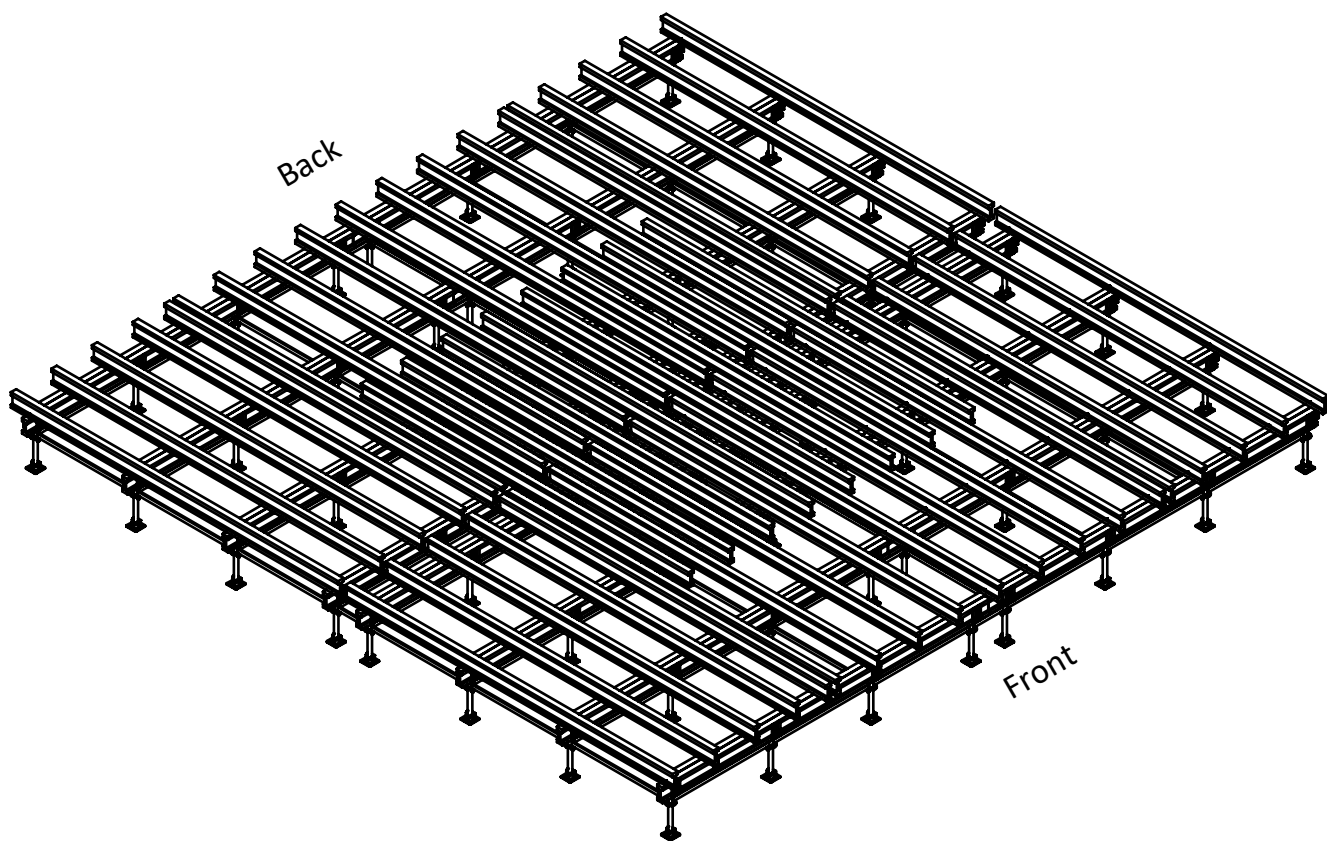

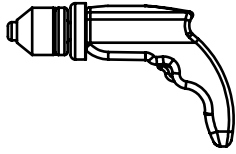

X160

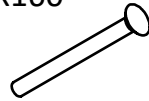

X32

5. Screwdriver for bits, battery
Not included

Wood Screw 4,5x45
2000443

X1



Bits TX 25
2001123

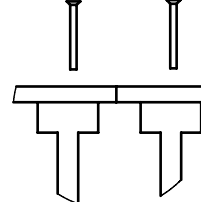
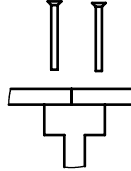
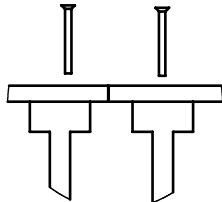

Plywood for podium
2000437

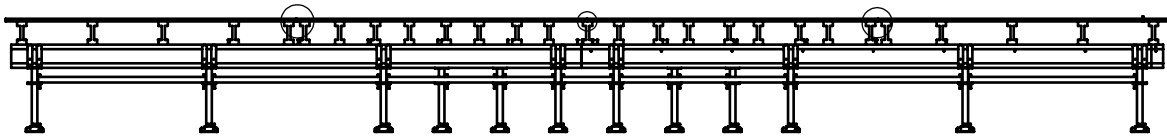

• Pattern for screws

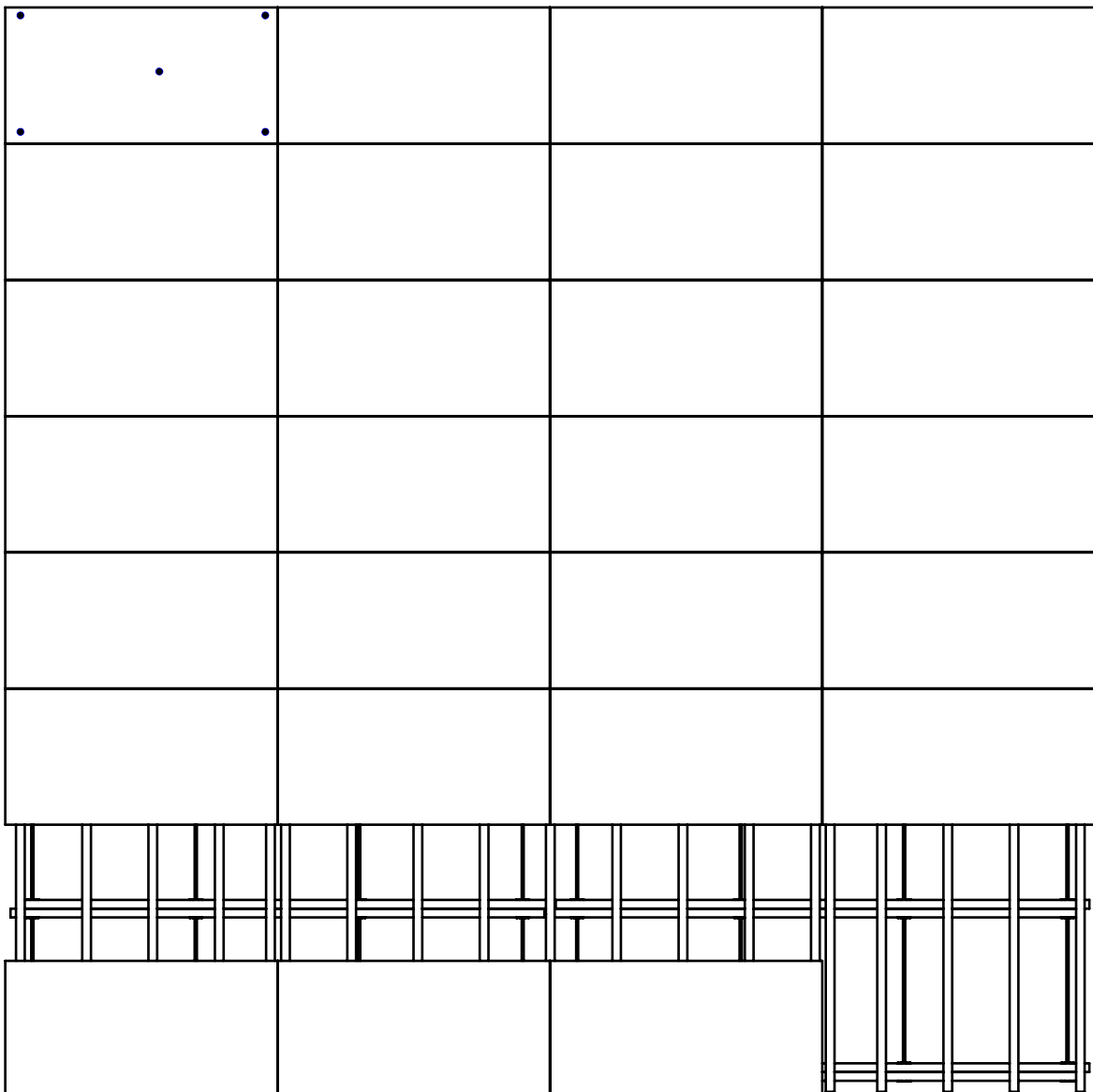

Front

ELEIKO

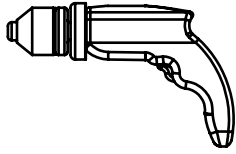

X160

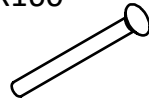

X32

6. Screwdriver for bits, battery
Not included

Wood Screw 4,5x45
2000443

X1



Bits TX 25
2001123

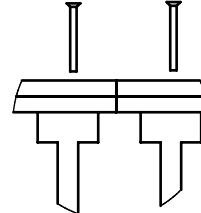
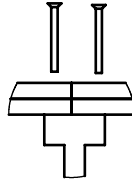
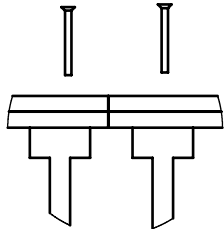

Plywood for podium
2000437

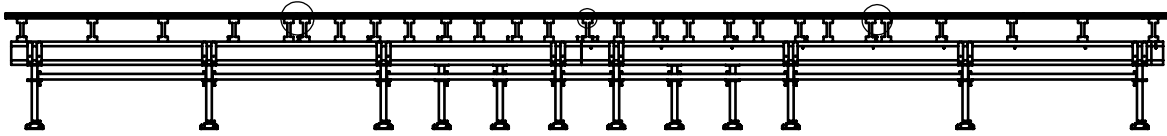

• Pattern for screws

Back

•							
•							

Front

ELEIKO

7.

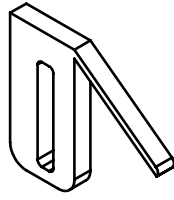

staple gun
Not included

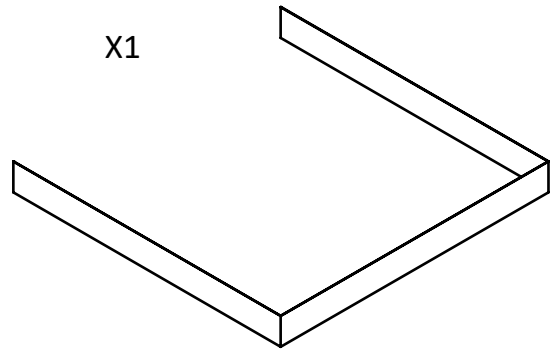

Banner L=30 m h= 1 m, Grey
2001049

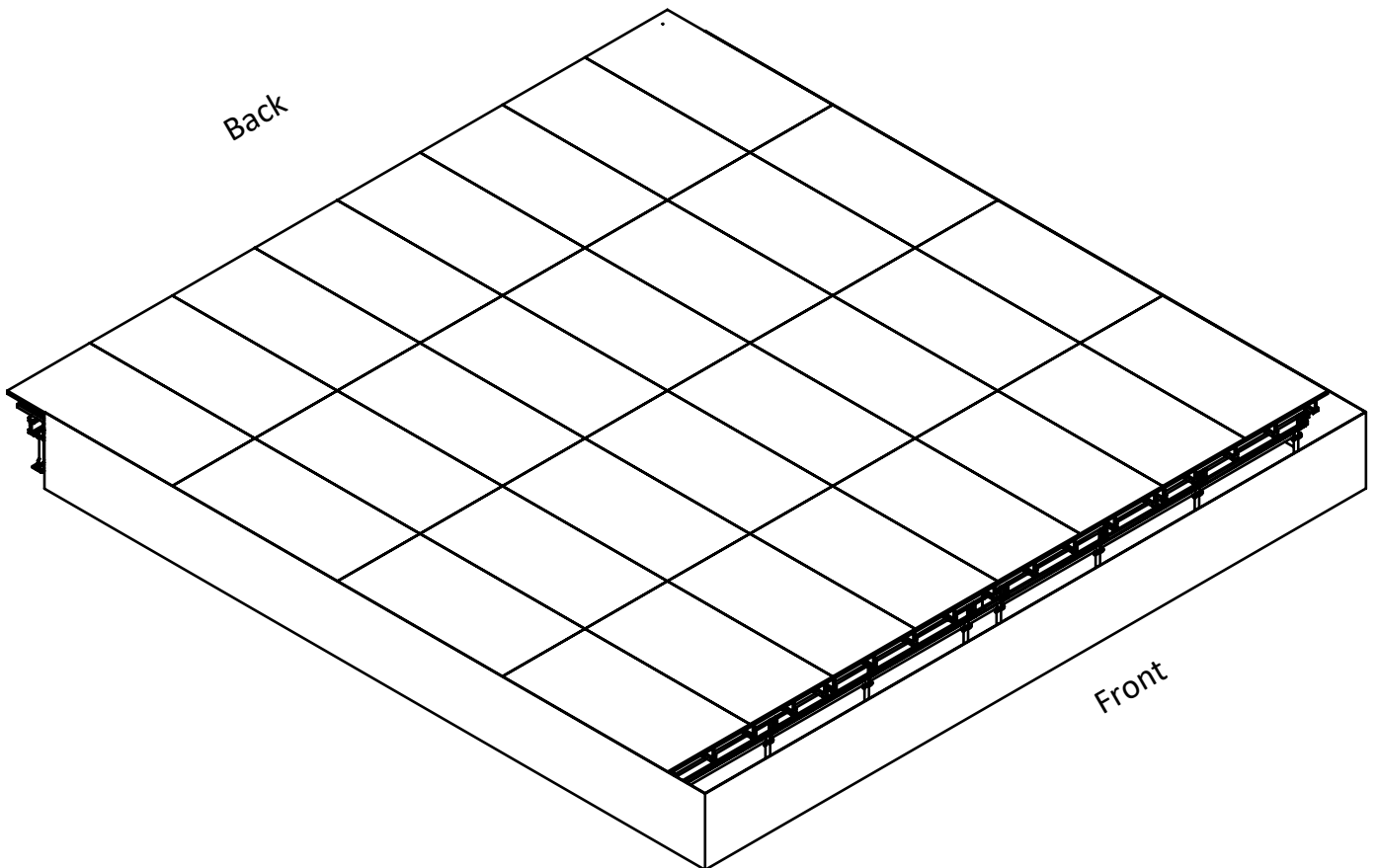

X2

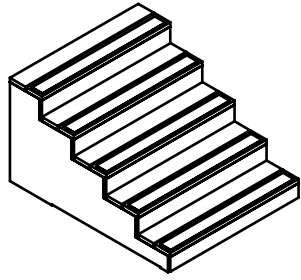

8.

Staircase for Podium IWF
2001052

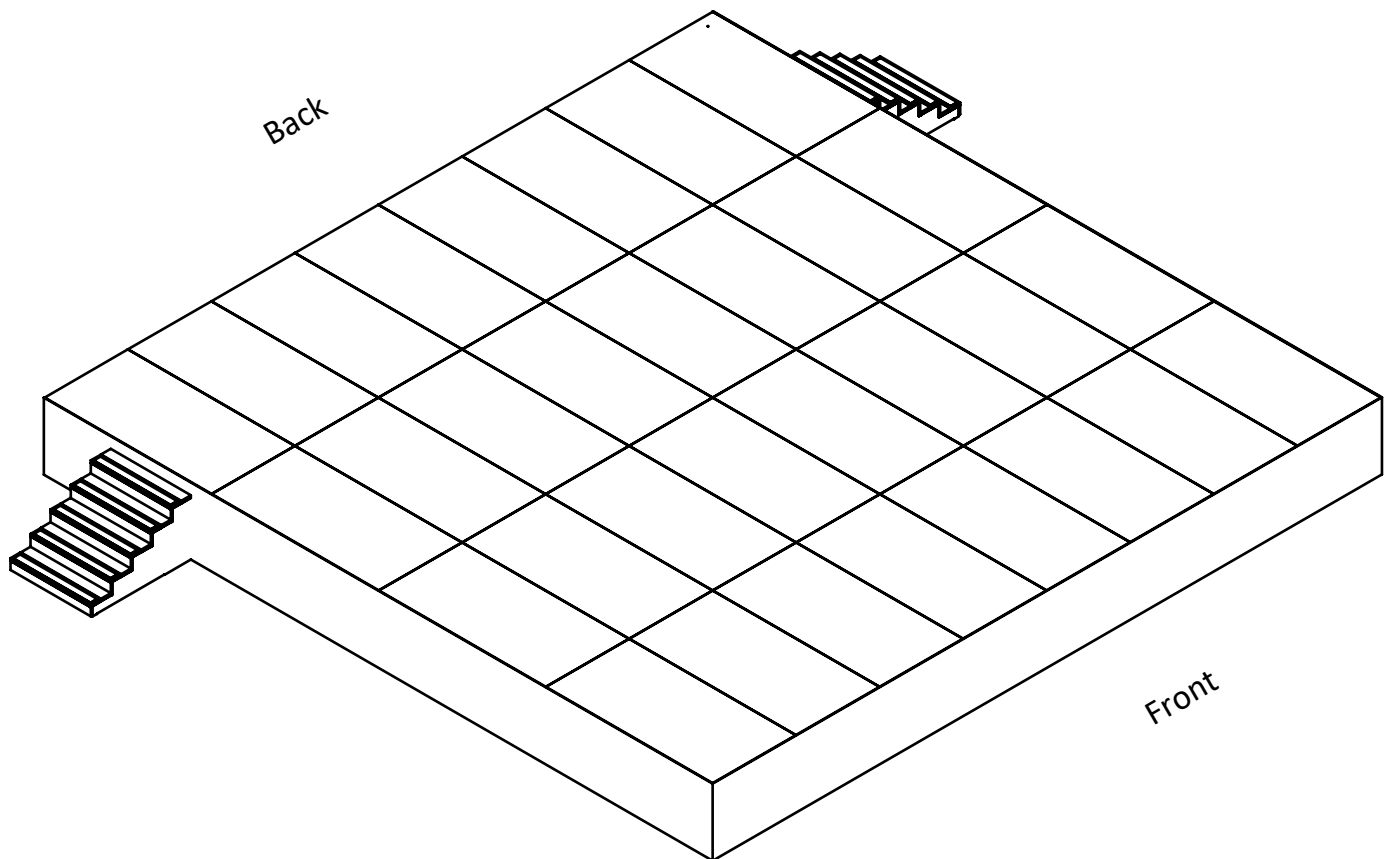

9.

X5

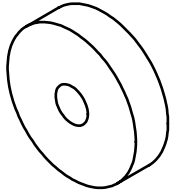

double-sided tape
3062723

X1

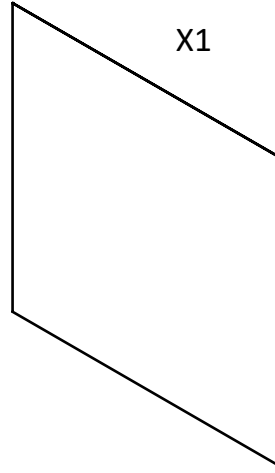

Carpet for podium, Grey 10x10 m
2001048

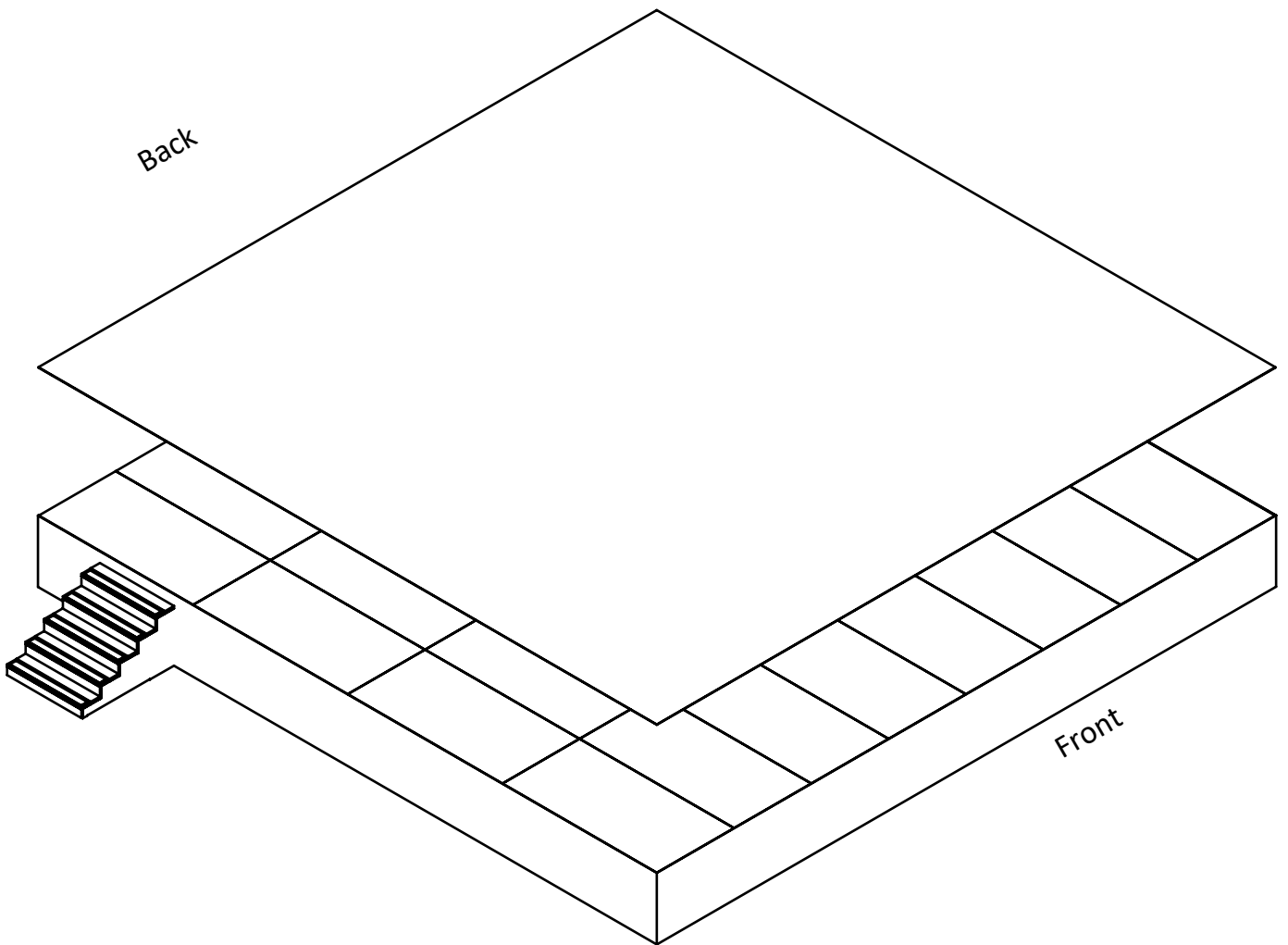

10.

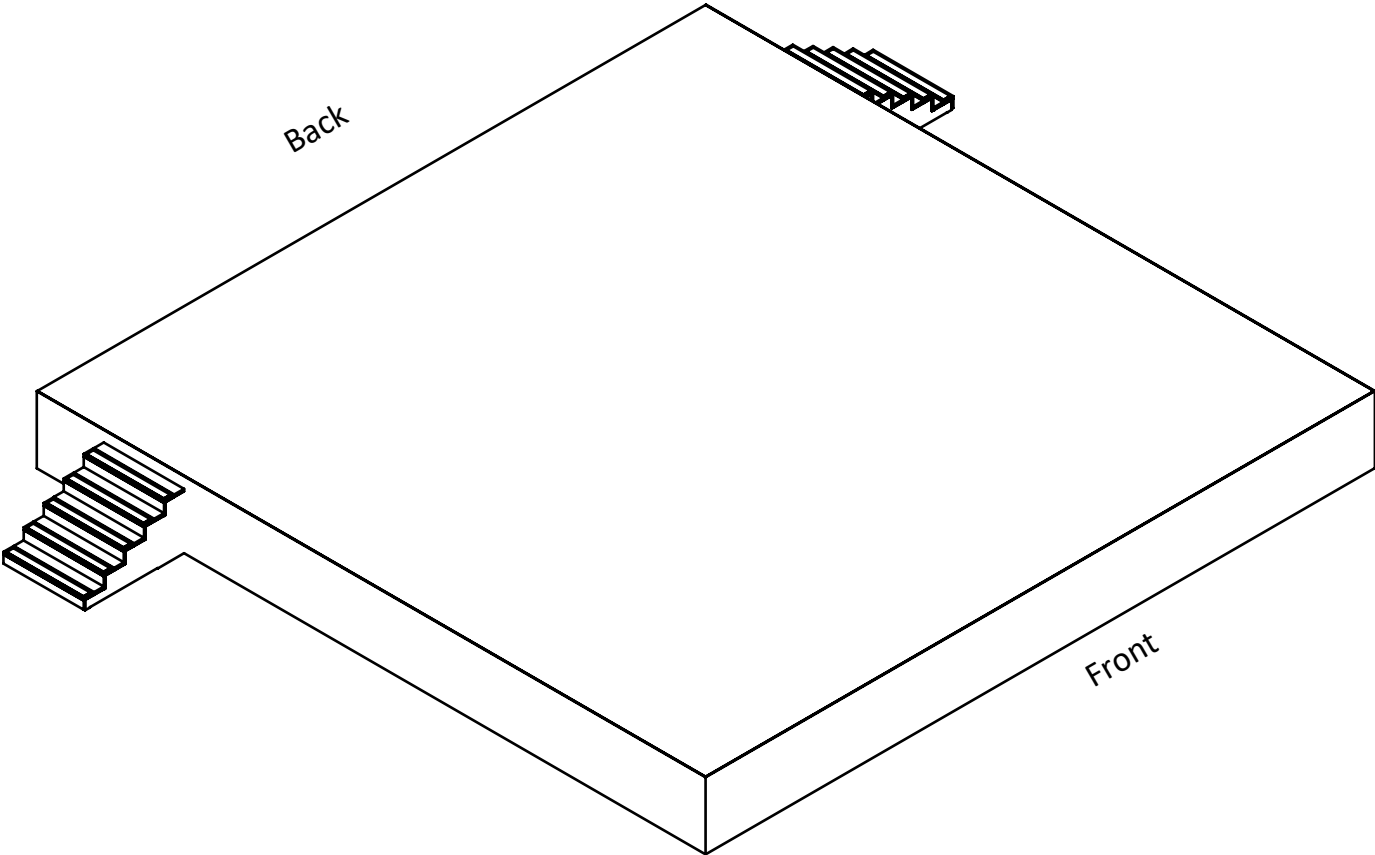

ELEIKO

RAISE THE BAR

Eleiko Group AB | Klastorpsvägen 18 | SE-302 62 HALMSTAD | Sweden
E-mail: info@eleiko.com | Phone: +46 35 17 70 70

www.eleiko.com